



ET-6AW Timerstat Instructions

WiFi Programmable Timerstat

The image displays a grid of 12 small thumbnail images showing various thermostat settings and features. A larger image of the thermostat display is shown on the right, displaying 20.0°C.



APP
for ET-6AW

Table of Contents.

01	Introduction.....	01
02	Technical Specifications.....	01
03	Installation.....	01
04	Wiring Instruction.....	02
05	Thermostat Symbols.....	03
06	Startup Wizard.....	04
07	WiFi Connection.....	05
08	Function and Operation.....	07
	8.1 Temporary Override Temperature.....	07
	8.2 Mode.....	07
	8.3 Key-Lock.....	07
	8.4 Menu.....	08
	8.4.1 Clock.....	09
	8.4.2 Event Setting.....	09
	8.4.3 Readout.....	10
	8.4.4 Advanced Setting.....	10
09	Open Window.....	12
10	Troubleshooting.....	13
	Dimension.....	14



INTRODUCTION

“ The 6A series is a smart thermostat used to control electric floor heating system or water heating system. It will keep home at comfortable temp whilst minimizing energy use. Install the app on your smart phone to control heating system remotely with the WiFi thermostat. ”

TECHNICAL SPECIFICATIONS

Supply voltage: 85-265Vac 50/60Hz	IP class: IP20
Standby power: <2W	Cable specification: ≤2.5mm ²
Max load: 16A	

INSTALLATION

- Step 1:**  Put your fingers into the gap between the front panel and frame then pull to separate them.
- »
- Step 2:**  Connect the wire as shown in the wiring instruction.
- »
- Step 3:**  Fix the back section to switch box with screws provided.
- »
- Step 4:**  Re-install front panel whilst ensuring the pins engage properly in the circuit board socket.

01

WIRING INSTRUCTION

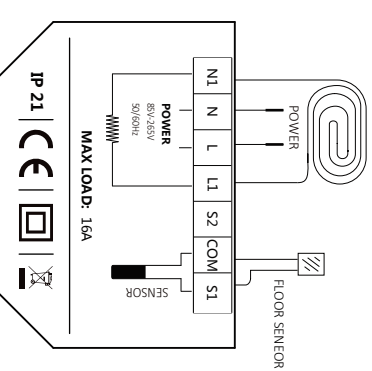

Please keep maximum load below 3500w or 23sqm mat (150w)

02

THERMOSTAT SYMBOLS

When the thermostat has been installed and electricity turned on, switch down the side switch to turn it on, switch up the switch to turn it off.

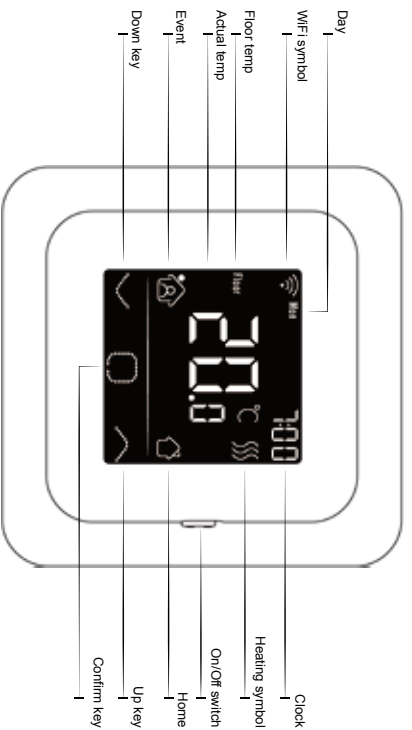

- Press the confirm-key to confirm the selection
- Press the up-key and down-key to select parameter:

STARTUP WIZARD

When the thermostat turns on for the first time, it will run startup wizard. The wizard leads you through a basic setup routine to ensure that you have the right settings.

<p>Clock</p> <p>Day set</p> <p>Hour set</p> <p>Minute set</p> <p>1</p> <p>3</p>	<p>Sensor selection</p> <p>There are 3 options:</p> <ul style="list-style-type: none"> Floor sensor: run by floor sensor(default). Room-in sensor: run by built-in room sensor. Both-in sensors: run by built-in sensor with floor temp limit. <p>2</p>
<p>Floor temp limit (If you choose Both sensors)</p> <p>If you choose both sensors, floor temp limit must be set to protect floor.</p> <p>3</p>	<p>Home or office</p> <p>Home</p> <p>Office</p> <p>4</p>

WiFi CONNECTION



Step 3: click "Add Device" on the bottom of the screen.

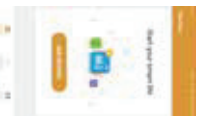

Step 4: Check the thermostat WiFi flag is fast flashing; if not, operate the thermostat according to the APP tips until it flashes quickly. Click the "Make sure WiFi is flashing quickly" button.



Step 5: Fill in the phone with the WiFi network password, click "confirm".



Step 6: Click "Done" after the APP is connected to the thermostat successfully. If it doesn't connect, check the WiFi is 2.4G version and that the signal is satisfactory. Use the AP mode to connect again.



Step 2: Click the APP, log in through the registered phone number or email address.

Step 1: Scan the QR code through a browser or download the APP from the major application markets to install it.

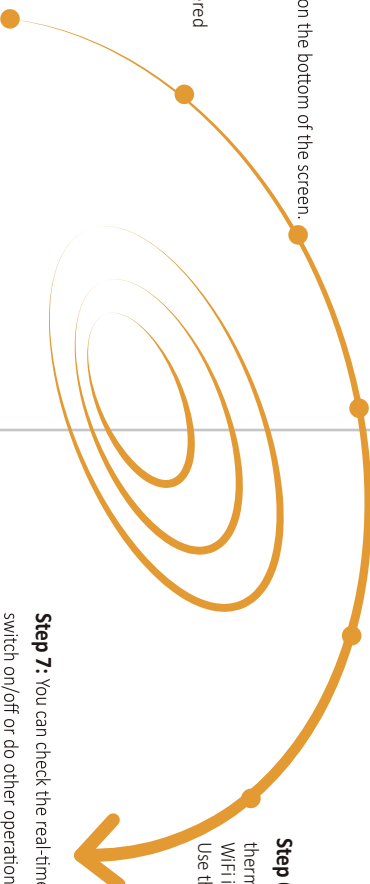

Step 7: You can check the real-time temperature, adjust or set the temperature, switch on/off or do other operations on the main interface.



FUNCTION AND OPERATION

8.1 Temporary Override Temperature



On the actual temp page, Press the up-key or the down-key to set temporary override temp. The temp is only valid at the current event and it will not be saved.

8.2 Mode



On the actual temp page, Press the confirm-key to enter mode selection.

There are 3 modes:

Auto mode: It is the default mode. Thermostat will run with event parameters to save energy. These parameters can be set in Event Setting. It will show home if you choose it otherwise office.

Manual mode: Thermostat will run with the set temp for ever.

Anti-frozen mode: Thermostat will run with the low setting temp for ever. The maximum is 15°C.

8.3 Key-Lock

Lock the keys to prevent the settings from being changed. On the actual temp page, press and hold the confirm-key and up-key for 3 seconds at the same time to lock or unlock all of the keys.

8.4 Menu

On the actual temp page, press and hold the confirm-key for 3 seconds to enter menu.

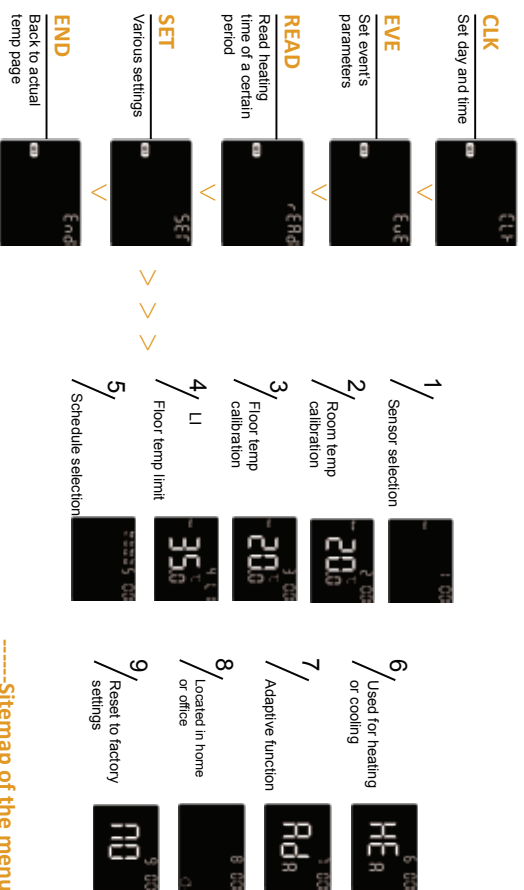

-----Sitemap of the menu

8.4.1 Clock

The default page of the menu is CLK. Day and clock is set here.

- Press the confirm-key to enter day set.
- Press the up-key or down-key to set day.
- Press the confirm-key to enter hour set.
- Press the up-key or down-key to set hour.
- Press the confirm-key to enter minute set.
- Press the up-key or down-key to set minute.
- Press the confirm-key to back to the actual temp page.

* If the thermostat is WIFI version, it will update time automatically after connect to WIFI.

8.4.2 Event Setting







In auto mode, program runs according to the parameters of the event. Event setting is the way to change the parameters. On the clock page, Press the up-key or down-key to select EVE.

- Press the confirm-key to enter day selection of event setting.
- Press the up-key or down-key to select a day or end.
- Press the confirm-key to enter the event selection of the day, or back to the actual temp page if you select end.
- Press the up-key or down-key to select a event.
- Press the confirm-key to enter the event's start time hour set.
- Press the up-key or down-key to set the start time hour.
- Press the confirm-key to enter the event's start time minute set.
- Press the up-key or down-key to set the start time minute.
- Press the confirm-key to enter the event's temp set.
- Press the up-key or down-key to set the temp.
- Press the confirm-key to back to the event selection, or back to day selection if the event is last one.

* If you want to back to the actual temp page, you should back to the day selection and select end.

09

Default parameters

Day	 (Wake)	 (Leave)	 (Back)	 (Sleep)		
Home	Mon-Fri Sat/Sun 06:00 06:00	20.0 °C 20.0 °C	08:30 08:30	15.0 °C 20.0 °C 17:00 17:00	2.00 °C 20.0 °C 23:00 23:00	15.0 °C 15.0 °C
Day	 (Work)	 (Off work)				
Office	Mon-Fri Sat/Sun 07:00 07:00	20.0 °C 15.0 °C	18:00 18:00	15.0 °C 15.0 °C		

8.4.3 Readout

Lookup the heating time (in percent) within a certain period.

On the clock page, press the up-key or down-key to select READ.

Press the confirm-key to enter Readout, the page will show the heating time in the last day.

Press the up-key or down-key to select 1 day, 30 days, 365 days, it will show the heating time within the certain period.

Press the confirm-key to back to the actual temp page.

8.4.4 Advanced Setting

The thermostat provides advanced settings to suit various special situations. These are normally set by technicians during initial installation.

On the clock page, press the up-key or down-key to select SET.

Press the confirm-key to enter advanced setting.

Each setting can be accessed by press confirm-key and adjust the parameter by press up-key or down-key.

10

Parameter.

No.	Name	Default	Ranges
1	Sensor selection	00: Floor sensor	00: Floor sensor 01: Room-in sensor 02: Both-in sensors 03: Room-out sensor 04: Both-out sensors
2	Room temp calibration	0,0°C	-5,0°C -- 5,0°C
3	Floor temp calibration	0,0°C	-5,0°C -- 5,0°C
4	Floor temp limit	35,0°C	20,0°C -- 50,0°C
5	Schedule	00: 7	00: 7 01: 5+1+1
6	Used for	00: Heating	00: Heating 01: Cooling
7	Adaptive function	00: Adaptive	00: Adaptive 01: No
8	Located in	00: Home	00: Home 01: Office
9	Reset	00: No	00: No 01: Reset

11

1. Sensor selection:

There are 3 options:

Floor sensor: run by floor sensor(default).

Room-in sensor: run by built-in room sensor.

Both-in sensors: run by built-in sensor with floor temp limit.

2. Room temp calibration: calibrate the temp detected by room sensor.

3. Floor temp calibration: calibrate the temp detected by floor sensor.

4. Floor temp limit: if you choose both sensors, floor temp limit must be set to protect floor.

5. Schedule: select a weekly schedule for the event.

There are 2 options:

7: each day from Mon to Sun can be set individually.

5+1+1: 5 days from Mon to Fri have the same events, Sat and Sun can be set individually.

6. Used for: heating or cooling.

7. Adaptive function: after several days of installation and use, Adaptive function ensures that the required temp has already been reached when the next event begins.

8. Located in: Home or Office.

9. Reset: all parameters are restored to default values.

8.5 Open window

If sensor selection is room sensor or both sensors, this function will find the sharply drop of the room temp.

When it happens, the thermostat shuts off the heating for 15 minutes. It can save energy and protect the floor. When the window is closed, turn the thermostat off then turn it on again, it will run properly again.

12

TROUBLESHOOTING

- E1:** Room-in sensor error.
- E2:** Floor sensor error.

DIMENSION(MM)

